

Varenummer: 3901030030400
 Beskrivelse: Snekkegear med fri indgangsaksel
 VF 30F-30-HS

Mål

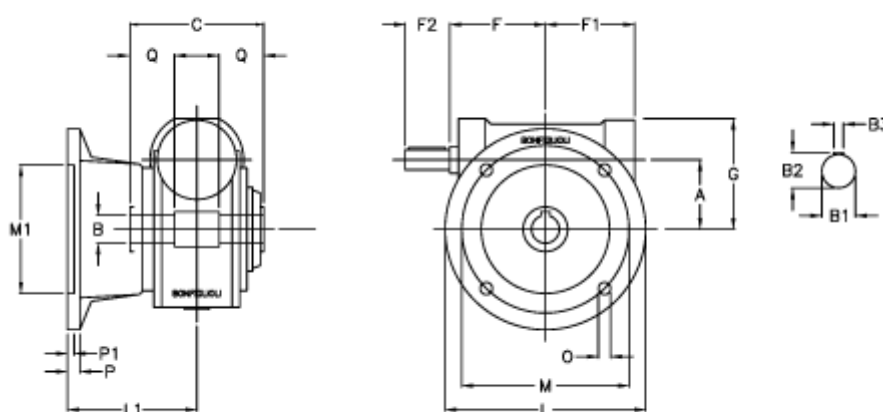

a	= 30.0	F1 = 46	P = 6
B	= 14	F2 = 20	P1 = 4
B1	= 9	g = 50	Q = 20.5
B2	= 10.2	L = 80	
B3	= 3	L1 = 50.5	
Betegnelse	= VF 30F-xx-HS	m = 68	
C	= 55	M1 = 50	
F	= 50.0	O = 6.5	